

Flush Ceiling Fitting

INSTRUCTION MANUAL

Safety Warnings

- This product is only suitable for connection to a 240V~50Hz supply in accordance with current IEE wiring regulations, and should be installed in accordance with local building regulations. It is for domestic, indoor use only, and is **not** suitable for a bathroom location.
- The light fitting should be connected to a lighting circuit protected by a 5 amp fuse (or a 6 amp miniature circuit breaker).
- Before installing your light fitting always switch off the mains supply, and remove the appropriate fuse or switch off the appropriate circuit breaker before commencing installation. Ensure that no one else has access that would enable the supply to be inadvertently reconnected.
- If the Class II, Double Insulated symbol  is on the light fitting, then the fitting does **not** require an Earth, and Live or Neutral **must not** be connected to Earth. If there is no such symbol the fitting **must** be Earthed. The terminal blocks are supplied according to requirements of the fitting.
- Never fit bulbs of a higher wattage than those specified on the label, as these may cause overheating and damage the fitting. This product may contain non-replaceable LEDs. If the fitting contains LEDs, and these fail, then the whole product must be replaced.
- If there is a “Minimum Distance” label, do not allow flammable materials to rest within that distance from the lamps.
- If the product must not be mounted on combustible surfaces there will be the below symbol on it. If there is no symbol then the product may be mounted on any wall surface, including combustible ones.
- This product may contain delicate parts – be careful during handling and maintenance to avoid breakage.
- If you are in any doubt about your competence please consult a qualified electrician.
- If any modification is made it will invalidate the warranty and may render the product unsafe.

Minimum Distance symbol:

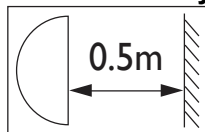

“Do not mount on flammable surfaces” symbol:

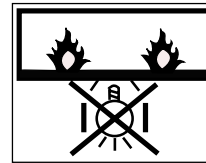

Care Information

Allow 10 minutes to cool before replacing, adjusting or cleaning.
Clean with a dry cloth only. Do not use liquid or abrasive cleaners on this product.

Assembly/ User Instructions

Before you start

Please read these instructions carefully before fitting and retain for reference. Check the packaging and make sure that you have all the required parts. Follow each assembly step in order to prevent incorrect assembly. Ensure that the product is fully assembled before use.

Please note - This instruction covers multiple fitting styles. While all the general steps to assemble your fitting will be the same, your individual product may vary from the diagram shown.

The Light pack contains:

Light fitting.
Terminal connection block(s).
Fixing pack.
Lampholder covers (as required)
Shade/ Bulb tool (as required)
Allen key (as required)

The following tools may be required:

Selection of cross and flat head screwdrivers.
Electric drill and assorted drill bits.
Wire strippers.
Electrical insulation tape.
Allen Keys
Personal protection equipment

These assembly diagrams are intended as a guide – if in doubt consult a qualified electrician.

Assembly/ User Instructions Continued

1. Decide on the position of the light fitting, or remove existing light fitting. Take a note of the position of the electrical connections. Ensure there is a solid mounting surface, preferably a wooden joist or joist bridge to support the weight of the light fitting.
2. Refer to generic diagrams.
3. Remove the side screws or finials (3) and retain for re-use.
4. In the case of Diagram 2, pull the house wiring through the fixing bracket.
5. Use the fixing bracket (1) as a template to mark the screw holes. Make the screw holes and secure to the ceiling with appropriate screw fixings (2), making sure the bracket is correctly aligned.
6. Support your fitting and connect the house wiring to the terminal block – see expanded wiring details below. The 4th terminal block connector is used for the “loop” wires of the “Ring Circuit”. There may be more than one set of cables in the “loop” connections. If there is a “Ring Circuit” and you do not understand the connections you must consult an electrician. Any loose terminal blocks – not secured to ceiling cup – should always be covered with 2 layers of good quality insulation tape.
7. Secure the ceiling cup over the bracket by using the screws or finials (3) removed in Point 3.
8. Slide the lampholder covers or “Candle Tubes” over the lamp holders, and affix any decorative beads, **if appropriate for your fitting**.
9. If there are shades, they can be fitted by removing the shade ring, sliding the shade over the lampholder and replacing the shade ring.
10. Fit the bulb(s), **if required**. **NOTE: Never fit bulbs of a higher wattage than those specified on the label (as these may cause overheating and damage the fitting).**
11. Turn on the power and test.

Diagram 1

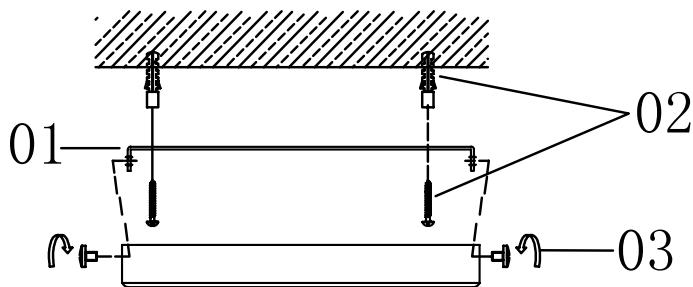
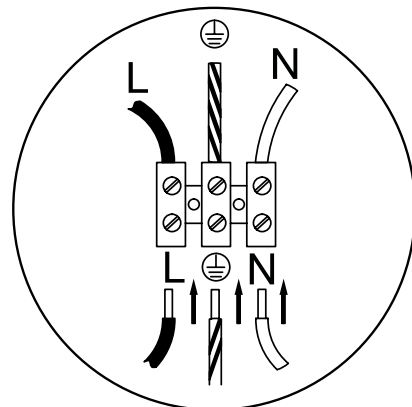
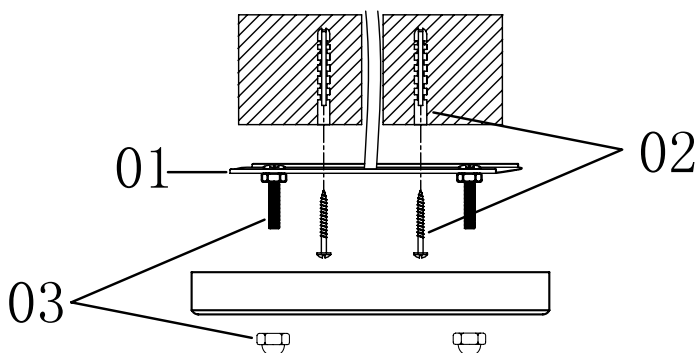
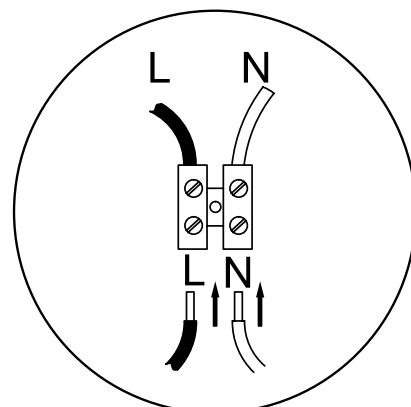

Diagram 2



Class I



Class II -
Double Insulated



- (EN) Scan QR code for multi-language
- (FR) Scannez le code QR pour plusieurs langues
- (ES) Escanee el código QR para varios idiomas
- (PL) Zeskanuj kod QR dla wielu języków
- (DE) Scannen Sie den QR-Code nach mehreren Sprachen
- (IT) Scansiona il codice QR per multilingua